



ThermalDESIGNS®

1880 South Flatiron Ct.
Boulder, CO 80301
866-442-3485 fx 303-442-3520
www.thermaldesignsinc.com
sales@thermaldesignsinc.com

Installation Instructions for Side Mount Add-On Track Motorized Shades - Wall Switch Operated

Install Tracks

1. Mount the shade tracks to sides of glazing bars, open side facing out, using flat head screws provided, through countersunk holes in track. BEGIN with bottom end of track at front of room, working upward to top of track at top of room. Bottom of track butts up against bottom frame of bay. Top of tracks should end at least 4" below/in front of ridge or wall. Be sure each tracks are level and even with each the other.
2. If bottom of track is open (not against frame), insert shade stop screw into pre-drilled holes 1/2" from bottom of track.

Install Motor Brackets & Headrails

3. Mount motor brackets to ridge header, wall or sunroom frame, below and aligned with inside edge of glazing bars...

OR, mount motor brackets low, onto sides of glazing bars...

Motor tubes will span across bays under glazing bars. Mount brackets so there will be at least 1/4" clearance below glazing bars and top of motor tubes.



Bracket mounted to ridge wall (motor end bracket)



Or, onto side of glazing bars (motor end bracket & intermediate tube connecting bracket)



Mounting options for brackets and headrails:

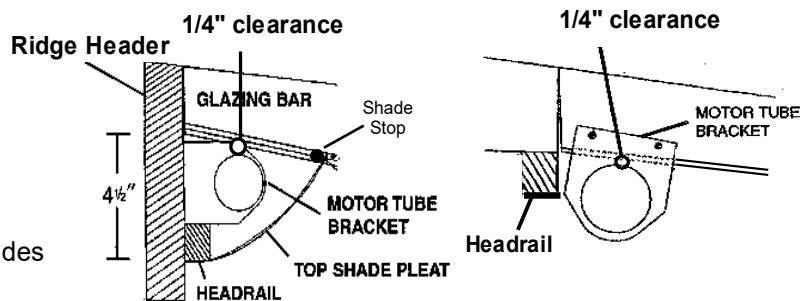

4. BEFORE PLACING MOTOR TUBES IN BRACKETS, mount headrails to ridge or wall, just below motor brackets, level and centered between tracks, through pre-drilled countersunk holes, velcro facing down.



Head rail, ridge/wall mount

5. Place motor tubes in brackets. Intermediate motor tube connecting brackets join motor tubes using the brass connecting rod.

Position motor end in bracket so the yellow limit switch cap faces out/down. Position intermediate motor tubes so the set screw holes in the tube end caps face out and down for easy access. Secure these tubes to brass connecting rods through center ring of brackets with set screws and thread locker provided.

6. Secure motor end stud in motor bracket with cotter pin. Bend the pin slightly to secure.

Install Cord Idler Tubes (if provided or skip to step 9.)

7. Idler tubes direct the cords off the back of the shades and down to the motor tubes. This eliminates cord tension against back of shade rods.
8. Attach the swivel lock bracket sets to the inside face of glazing bars, just above edge of tracks. Here is an example installation:



Swivel lock bracket for cord idler tube



Idler tube in place above track and motor.

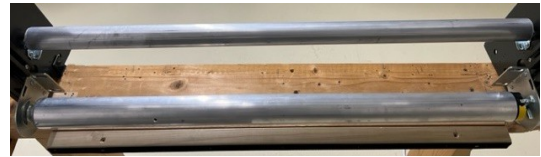

Idler tube on brackets above motor tube.

Load Shades

9. Shades are labelled in alpha order from left to right (inside of room looking out), if they are not all the same size. Complete all loading and shade cord steps before starting the next shade.
10. Load the shades: Put clamp in track a couple of feet below top. Begin loading glider wheels in bottom of shade first into top end of tracks, bottom of shade has the cords on the back, cords face the glass. Each glider wheel must sit on edge of track opening. CAUTION: Glider wheels do NOT go completely inside of track:
11. Install shade stop screws into pre-drilled holes located 1/2" from top of tracks to keep wheels from falling out during operation (stop screw will not be necessary in bottom of track if it is closed off by window bay frame). Screw in just enough to block wheels as shown:
12. Spray silicon onto glider wheels and edge of track. CAUTION: Excess silicone will drip from bottom of tracks. Clean up any silicone over-spray.

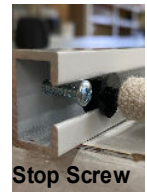
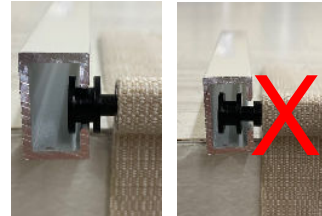
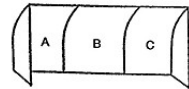

Stop Screw

Shade Cords

13. Unbundle the cords, draping them over top of shade. Pull top of shade up near the motor tube & move clamp under top shade glider, letting rest of shade slide down the tracks.

If using cord idler tubes, run cords over top of idler tube down to the motor tube:
14. Starting 12" in from side of glazing bar, wrap each cord 2 times OVER TOP OF MOTOR TUBE TOWARD THE CENTER of tube. Wrap cords taut around tube but not enough to lift the bottom of shade.
15. Attach clips over wrapped cord. Once attached, you can twist the clips to tighten cord tension if needed. Match tension equally on both cords to minimize later adjustments. Cut off extra cord length hanging from clips.



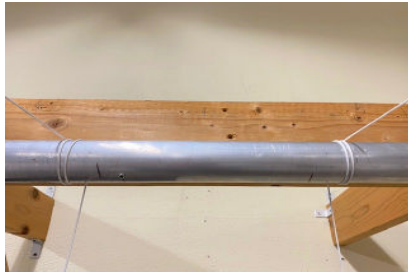

Wrap cords twice over tube toward center

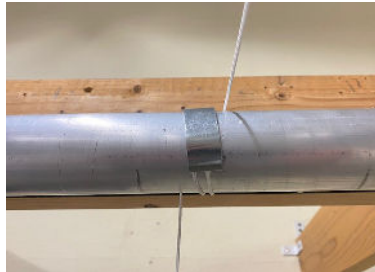

Cord clip - Right side



Rotate clip to tighten cord if needed

- When finished with one shade, attach shade velcro to headrail and remove clamp from track. Repeat this process for each shade ensuring all cords on all shades have the same tension before operating the motor.

Initiate Motor Operation

A motor test adapter plug is provided to set the motor's upper and lower limits prior to hard wiring to the wall switch.

- Remove the yellow protective cap on the motor end of tube covering the limit switch push buttons. This is best done using a small flat screw driver or needle nose pliers. Fully depress both white and yellow buttons so they lock in the recessed position (use screw driver or plier tip) Do Not discard the cap.

Motor test adapter

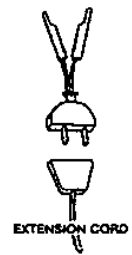

Motor on the Right - Remove yellow cap



Depress both buttons after removing cap

- Run an extension cord for the test adapter, close to the motor cable and plugged into nearest outlet. Use one of the following guidelines to RAISE the shades using the test adapter - test adapter is unplugged for the moment:

IF MOTOR IS ON THE RIGHT when facing the motor tube, attach either one of the alligator clips on the adapter to the motor's RED wire and the other clip to the White neutral wire (leave motor's black and green wires alone).

IF MOTOR IS ON THE LEFT when facing the motor tube, attach either one of the alligator clips on the adapter to the motor's BLACK wire and the other clip to the White neutral wire (leave motor's red and green wires alone).

Check that shades raise properly

- Run motor up to raise shades: Plug in test adapter to extension cable - Let motor tube rotate 3-4 revolutions and Stop/Unplug adapter. Check cords:

If any shades are raising unevenly, adjust cord tension by twisting the cord clips on motor tube appropriately. When bottom of shades are all even, tension is correct. Also note that cords will wrap around tubes away from clips in a telescoping pattern.

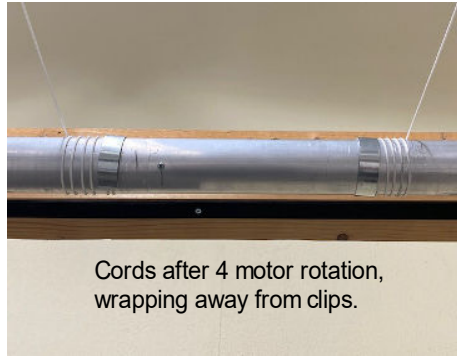

20. Ensure top of shade is firmly and evenly attached to velcro on headrail, with no headrail showing.

Set Motor Upper and Lower Limits

21. Continue raising shades until they reach your desired maximum open position (upper limit), Stop/unplug adapter. STOP BEFORE SHADE PLEATS BUNDLE TOO TIGHTLY against shade stop screws.

IF MOTOR IS ON THE RIGHT, press and release yellow button so it pops back out. Upper limit is now set.

IF MOTOR IS ON THE LEFT, press and release white button so it pops back out. Upper limit is now set.

22. Swap the RED/BLACK motor wire attached to the adapter clip (If you ran shades up using RED motor wire, disconnect it from the adapter clip, and connect the BLACK motor wire to the clip, or vice verse).

Plug in test adapter to extension cord and begin lowering shades.

IF SHADES ARE NOT LOWERING EVENLY OR SMOOTHLY, STOP! More silicone spray is needed. Raise shades back to upper limit, apply more silicone to wheels and tracks before lowering again.

23. When bottom of shades reach your desired lowest, closed position, Stop/unplug adapter. Press and release the remaining button on the motor so it pops back out. Lower limit is now set.
24. Test Drive - Raise the shades up and down to confirm upper and lower limits and shades run up and down smoothly and evenly.

CAUTION: Motors are not able to run continuously up and down for long periods. Once the motor becomes overheated, it will shut down and cannot operate until cooled. The cool down time is at least 10 minutes.

Note: Motor limit settings should be set BEFORE hard wiring to wall switch.

Motor Wiring Diagram:

Below is the wiring diagram for your wall switch, provide to your electrician. It is also found printed on the inside of the switch container box.

ONE MOTOR / SINGLE POLE SWITCH

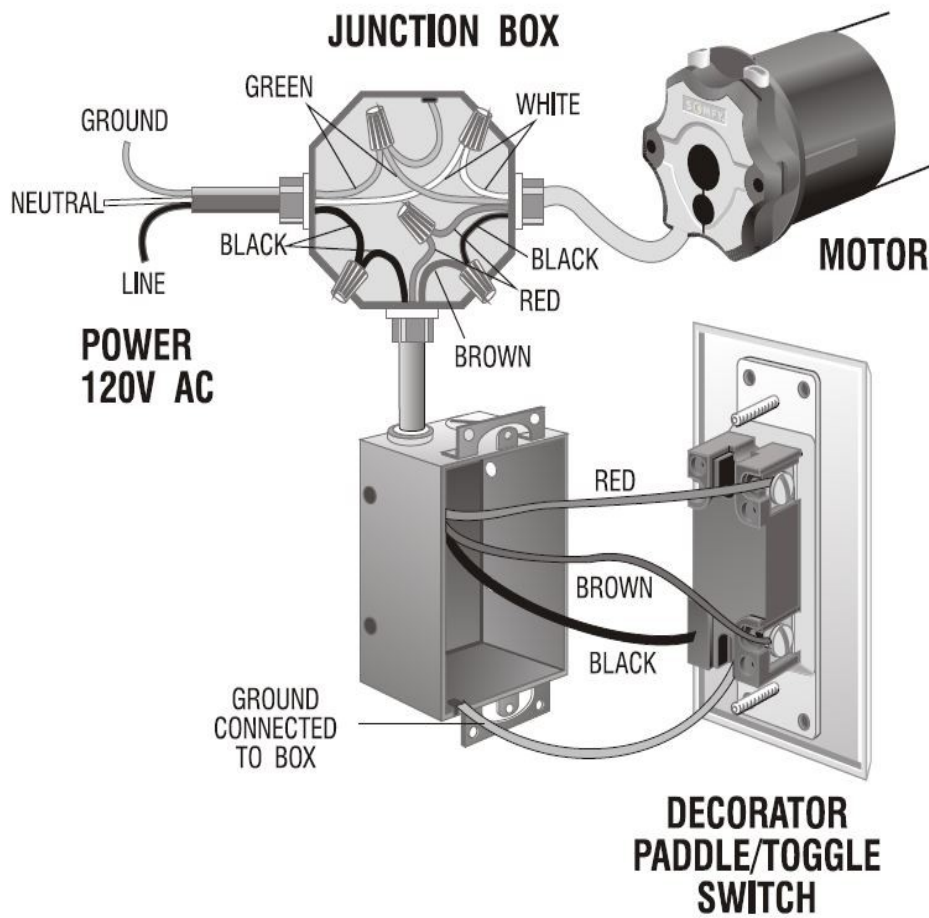

Black (to brown) and red wires from motor are directionals